

# TABLE SOCCER

## ASSEMBLY INSTRUCTIONS

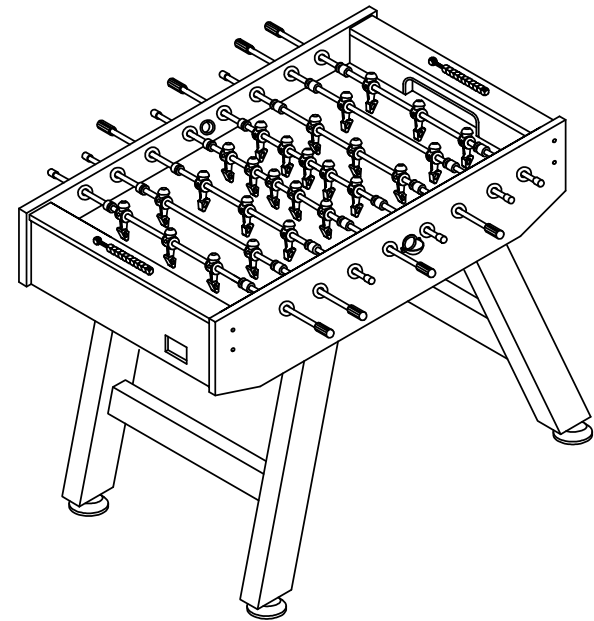

# ASSEMBLY INSTRUCTIONS

## SOCCER TABLE ASSEMBLY

**WARNING: TWO ADULTS NEEDED TO ASSEMBLE SOCCER TABLE**

- INSERT THE PLAYER RODS **C1&C2&C3** THROUGH ONR SIDE PANEL, THEN INSERT PLAYERS **C8&C9** AND RUBBER BUSHINGS **C4**, PLASTIC WASHERS **C5** THROUGH THE ROD, REFER TO **R1~R6**. THEN INSERT THE PLAYER ROD THROUGH OTHER SIDE PANEL, ATTACH THE PLAYERS **C8&C9** WITH BOLTS **C6** AND NUTS **C7**. SEE **Figure 6**.
- SLIDE THE HANDLES **P7** ONTO THE ENDS OF THE RODS WITH BOLT **H8**. SLIDE THE RUBBER CAPS **P8** ON THE OTHER END OF THE ROD .



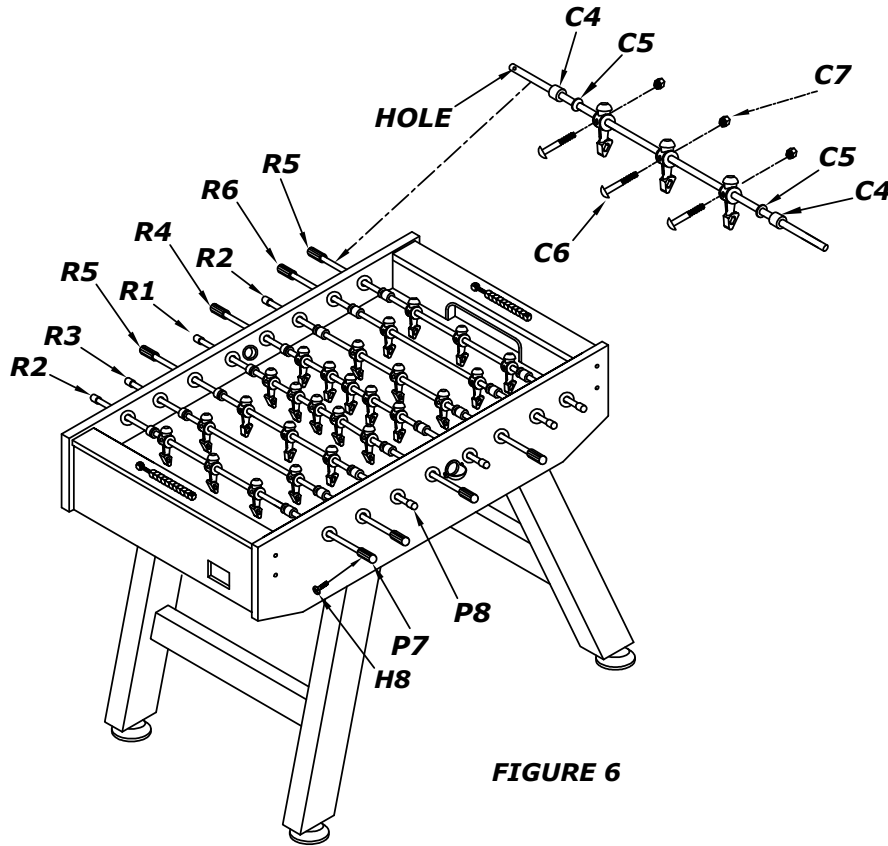

**Tighten all the hardware before playing games !**



**FIGURE 6**

# PARTS IDENTIFIER

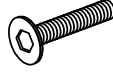
## HARDWARE

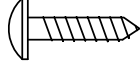
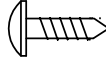
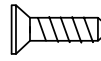
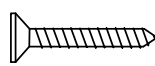
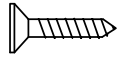



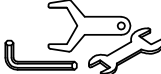





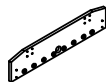

		DESCRIPTION	QTY. REQUIRED <small>(EXTRA PIECES MAY BE INCLUDED)</small>
	<b>H1</b>	M8x90 BOLT	16
	<b>H2</b>	M8 WASHER,	32
	<b>H3</b>	M8 LOCK HEX NUT	16
	<b>H4</b>	M6x46 BOLT	8
	<b>H5</b>	M6 WASHER	8
	<b>H6</b>	1-1/8"ROUND HEAD SCREW	14
	<b>H7</b>	5/8"ROUND HEAD SCREW	38
	<b>H8</b>	BOLT (use to screw the handle)	8
	<b>H9</b>	1-1/2"FLAT HEAD SCREW	4
	<b>S1</b>	5/8"FLAT HEAD PHILLIPS SCREW	24

## ACCESSORIES

		DESCRIPTION	QTY
	<b>A1</b>	SOCCER BALL	4
	<b>A2</b>	TOOL	4

# PARTS IDENTIFIER

## ASSEMBLY PARTS

	DESCRIPTION	QTY
	<b>P1</b> SIDE PANEL	2
	<b>P2</b> END PANEL	2
	<b>P3</b> PLAYING FIELD	1
	<b>P4</b> LEG	2
	<b>P5</b> PLAYFIELD SUPPORT BRACE	3
	<b>P6</b> SLIDE SCORER	2
	<b>P7</b> HANDLE	8
	<b>P8</b> ROD END CAP	8
	<b>P9A</b> BALL ENTRY CUP	2
	<b>P9B</b> BALL ENTRY SOCKET	2
	<b>P10</b> LEG LEVELER	4
	<b>P11</b> BALL CATCHER	2
	<b>P12</b> SUPPORT BRACKET	6

# ASSEMBLY INSTRUCTIONS

## SOCCER TABLE ASSEMBLY

**WARNING: TWO ADULTS NEEDED TO ASSEMBLE SOCCER TABLE**

- ATTACH BALL ENTRY CUPS **P9A** AND **P9B** TO THE SIDE PANELS WITH SCREWS **H7** AS SHOWN IN **figure 5**. ATTACH THE TWO SETS OF SLIDE SCORER **P6** TO THE END OF TABLE WITH PHILLIS HEAD SCREWS **H9**. ATTACH THE ROD BUSHING **C10A&C10B** TO THE SIDE PANELS AS SHOWN IN **FIGURE 5**.
- ATTACH THE PLASTIC **#2a, #2b, #3a, #3b**, TO THE PLAYING FIELD WITH **S1** AS SHOWN IN **Figure 5**.

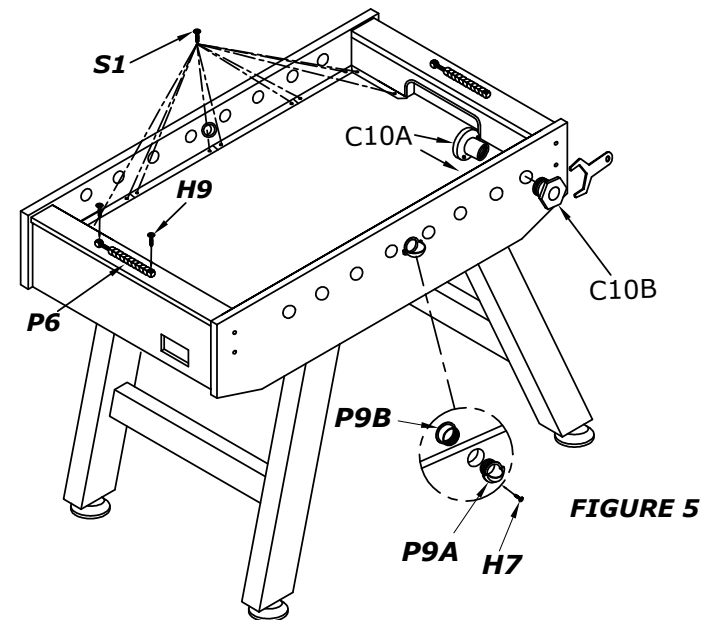

**FIGURE 5**

Play surface  
TOP VIEW

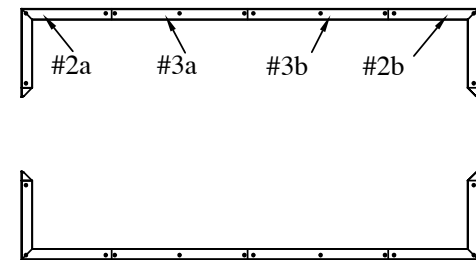

# ASSEMBLY INSTRUCTIONS

## SOCCKER TABLE ASSEMBLY

**WARING: TWO ADULTS NEEDED TO ASSEMBLE SOCCER TABLE**

- ATTACH THE BALL CATCHER **P11** TO THE END PANEL WITH **H6** AS SHOWN IN **figure 3**.  
(THE BALL CATCHER DISTANCE TO THE SIDEPANEL 60mm)

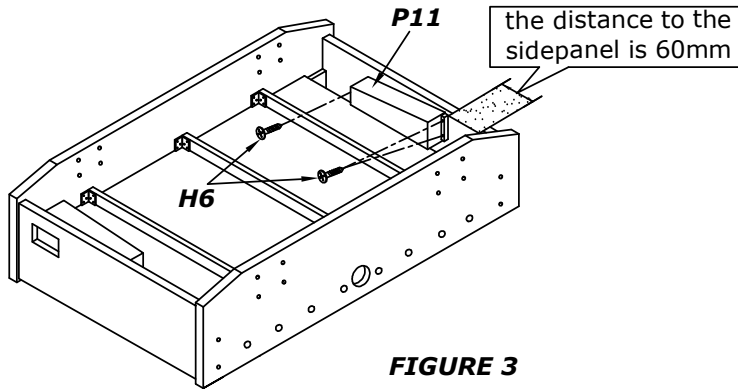

**FIGURE 3**

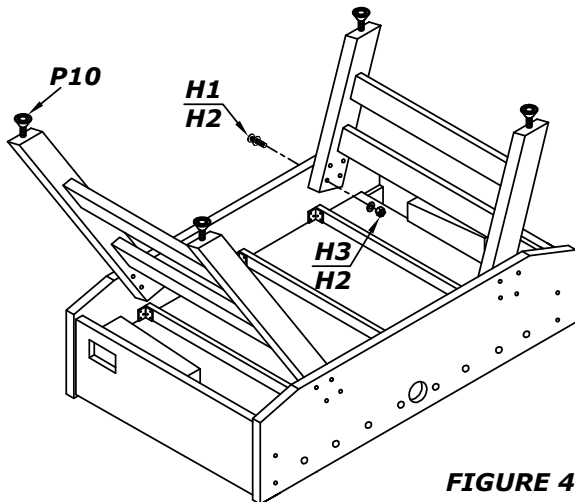

- ATTACH THE LEGS **P4** WITH BOLTS **H1**, NUT **H3** AND WASHERS **H2** AS SHOWN IN **figure 4**.
- ATTACH THE LEG LEVELERS **P10** AS SHOWN IN **figure 4**.



**FIGURE 4**



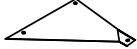
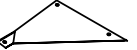
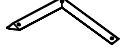
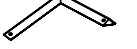



# PARTS IDENTIFIER

## ASSEMBLY PARTS

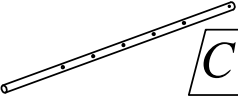
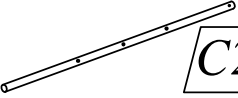
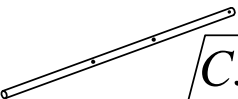
	#1a	TRIANGLE a	2
	#1b	TRIANGLE b	2
	#2a	L STYLE PLASTIC a	2
	#2b	L STYLE PLASTIC b	2
	#3a	LONG PLASTIC a	2
	#3b	LONG PLASTIC b	2

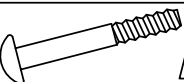
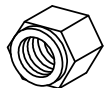
# PARTS IDENTIFIER

## REPLACEMENT PARTS

	DESCRIPTION	QTY
 <b>C1</b>	5 PLAYER ROD	2
 <b>C2</b>	3 PLAYER ROD	4
 <b>C3</b>	2 PLAYER ROD	2
 <b>C4</b>	RUBBER BUSHING	16
 <b>C5</b>	PLASTIC ROD WASHERS	16
 <b>C6</b>	1-1/8" BOLT (used to install men)	26
 <b>C7</b>	LOCKING NUT (used to install men)	26
 <b>C8</b>	HOME MEN	13
 <b>C9</b>	AWAY MEN	13
 <b>C10A</b>	ROD BUSHING A	16
 <b>C10B</b>	ROD BUSHING B	16

# ASSEMBLY INSTRUCTIONS

## SOCCER TABLE ASSEMBLY

**WARNING: TWO ADULTS NEEDED TO ASSEMBLE SOCCER TABLE**

1. INSERT PLAY FIELD **P3** INTO THE GROOVE ON THE SIDE PANELS **P1** WITH GRAPHICS FACING DOWN. SEE **figure 1**

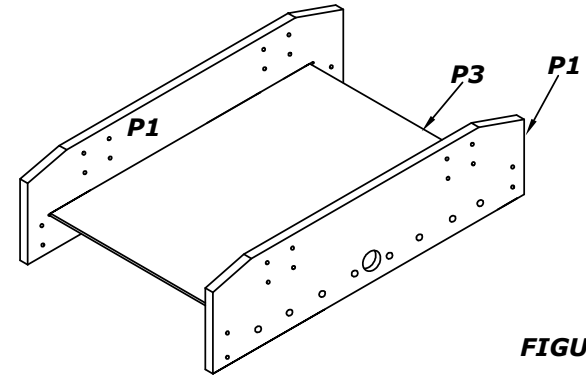

**FIGURE 1**

2. ATTACH THE TWO END PANELS **P2** TO THE SIDE PANELS **P1** WITH BOLT **H4** AND WASHER **H5** AS SHOWN IN **figure 2**.
3. ATTACH PLAY FIELD WITH SCREWS **H6** IN THE END AND SIDE PANELS AS SHOWN IN **figure 2**.
4. PLACE THE PLAYFIELD SUPPORT BRACES **P5** ON THE BOTTOM OF THE PLAYFIELD. ATTATCH THE BRACES USING BRACKETS **P12** AND SCREWS **H7**. AS SHOWN IN **figure 2**.

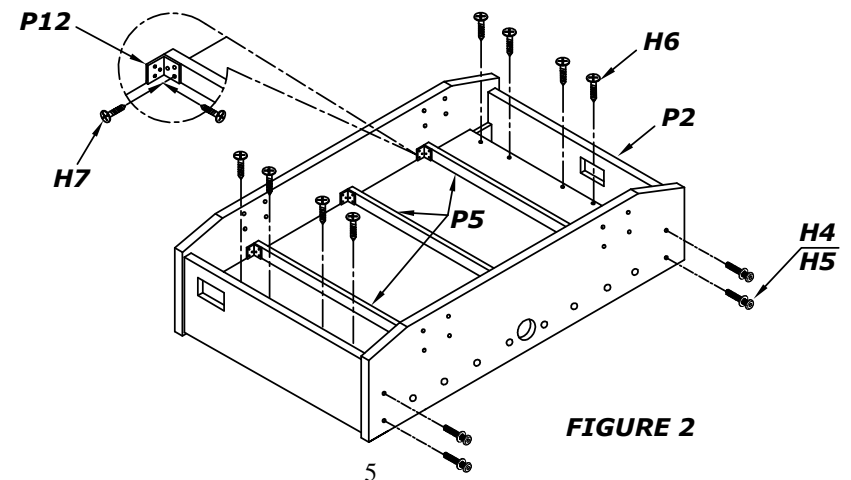

**FIGURE 2**

# ASSEMBLY INSTRUCTIONS

---

## SOCCER TABLE ASSEMBLY

---

WARNING: TWO ADULTS NEEDED TO ASSEMBLE SOCCER TABLE

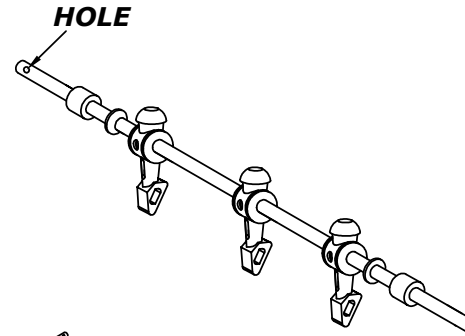

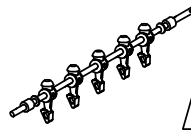
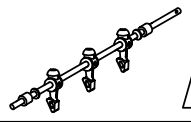
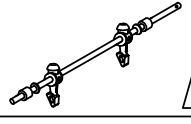
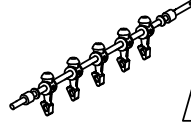
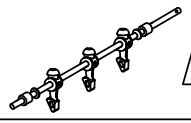
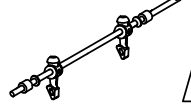
		<i>QTY</i>
	<b>R1</b> 5 HOME PLAYERS ROD	1
	<b>R2</b> 3 HOME PLAYERS ROD	2
	<b>R3</b> 2 HOME PLAYERS ROD	1
	<b>R4</b> 5 AWAY PLAYERS ROD	1
	<b>R5</b> 3 AWAY PLAYERS ROD	2
	<b>R6</b> 2 AWAY PLAYERS ROD	1